

CASA 3

Carrer de la Riera
Begur

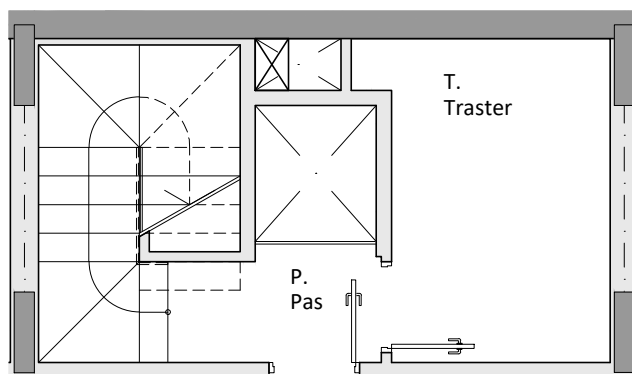

Pendent 5%

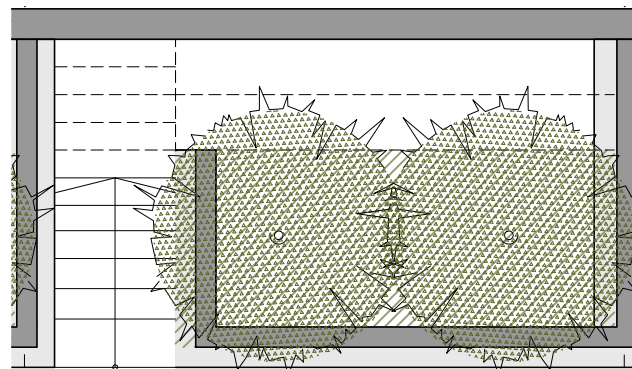
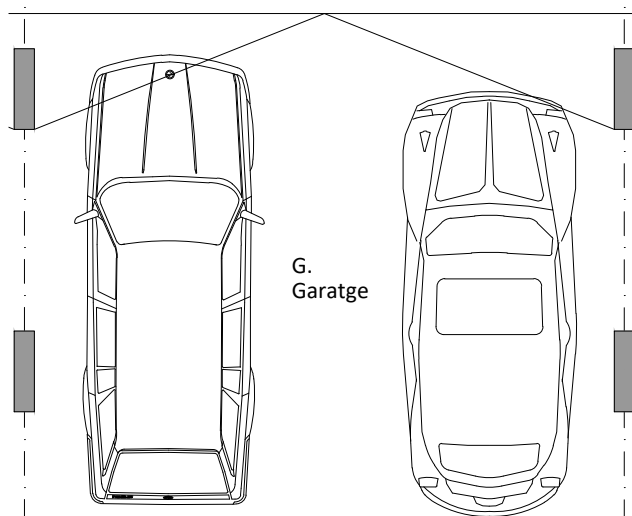

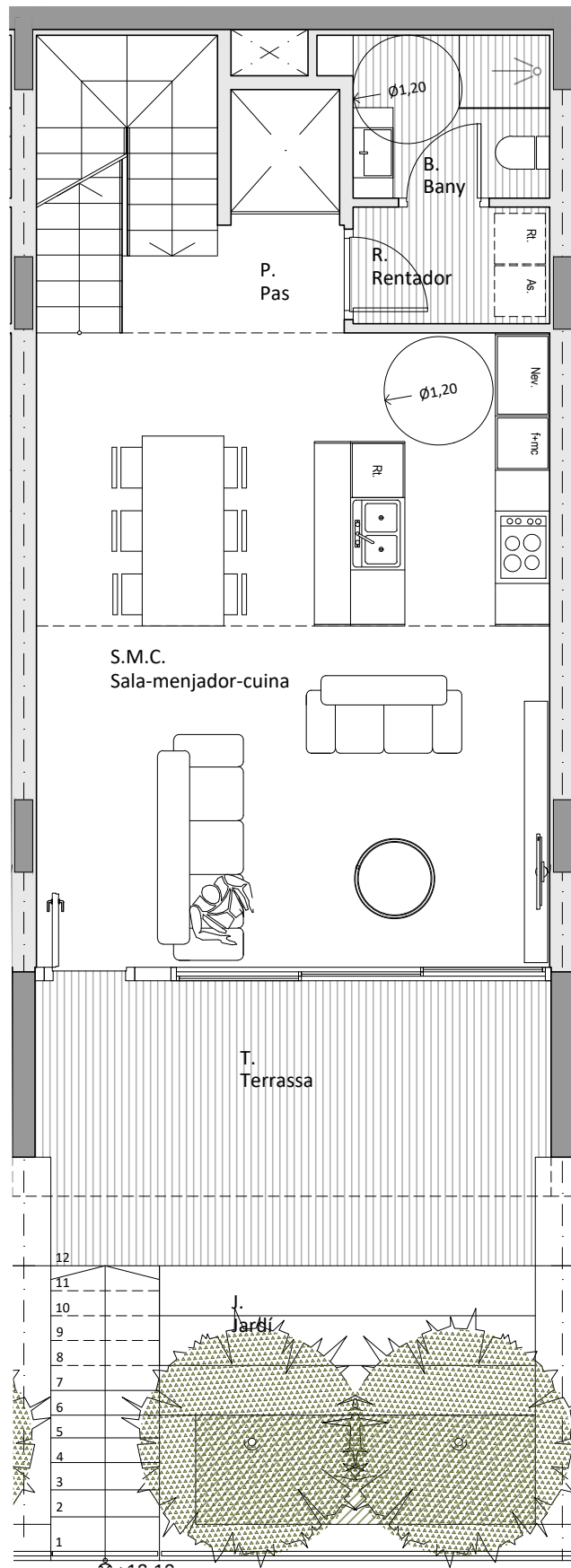

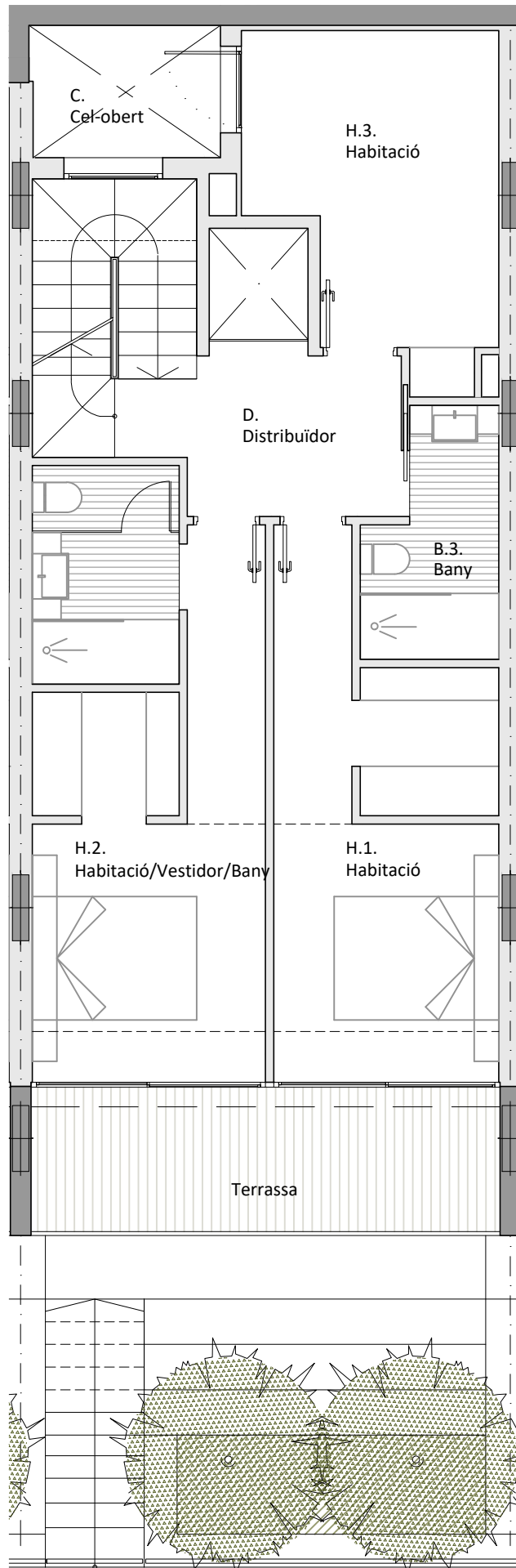

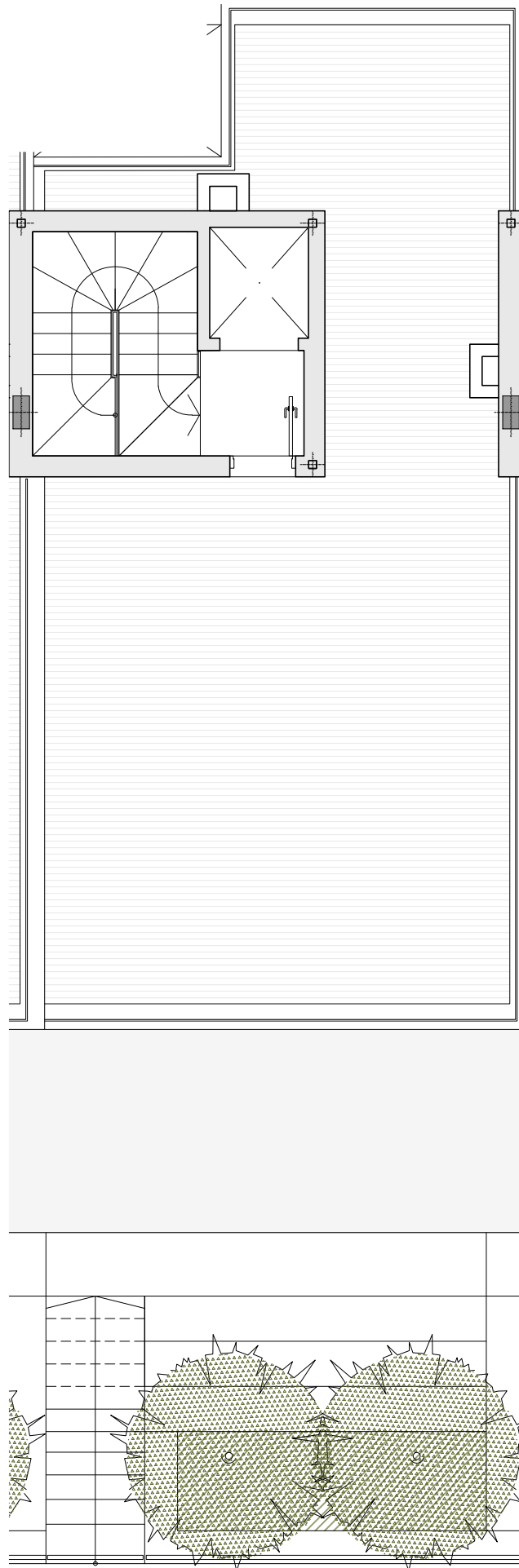

CASA 3
Planta coberta

Superfície construïda = 10,62 m²

Superfície transitable = 36,26 m²

e: 1/75 (A4)