

CASA 2

Carrer de la Riera
Begur

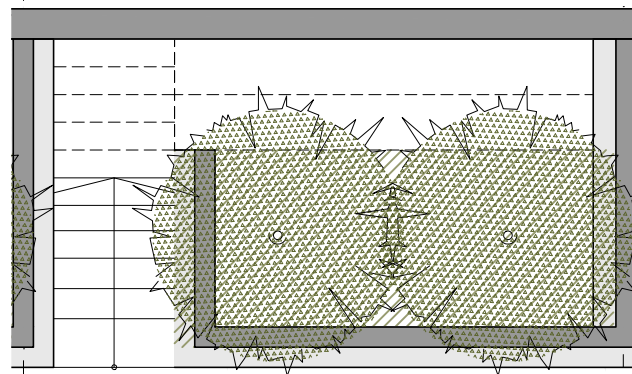

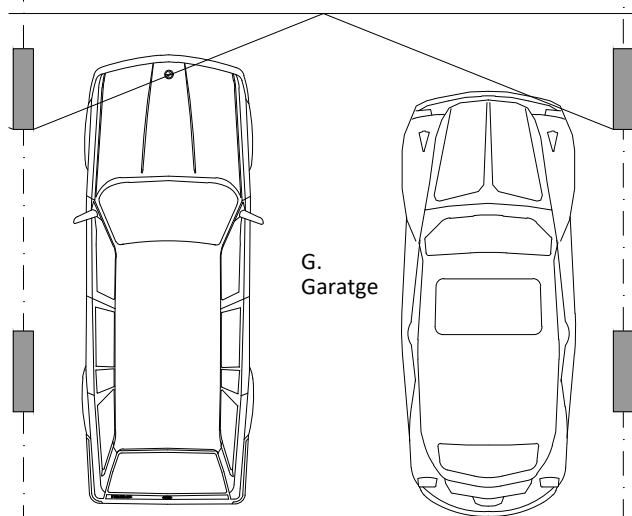

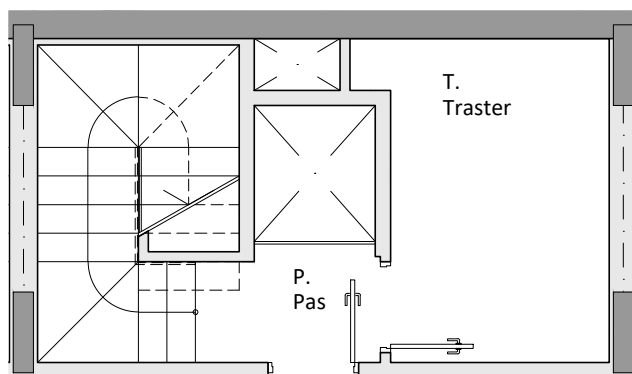
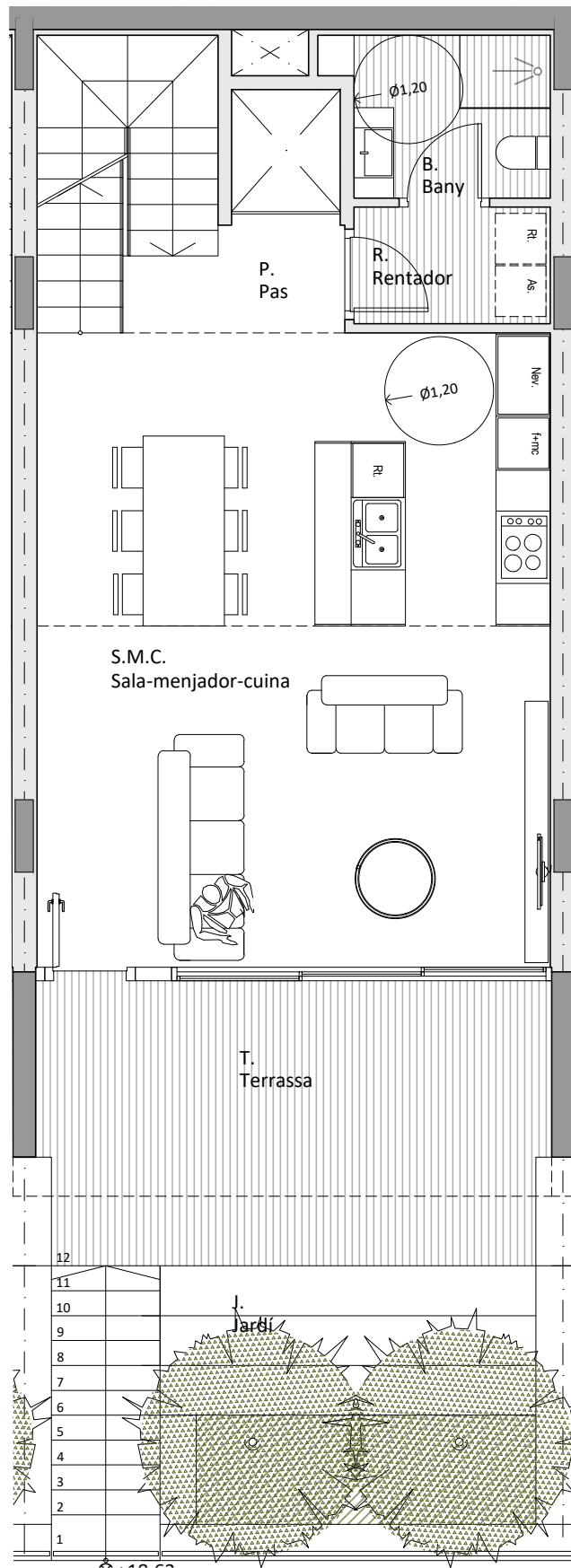
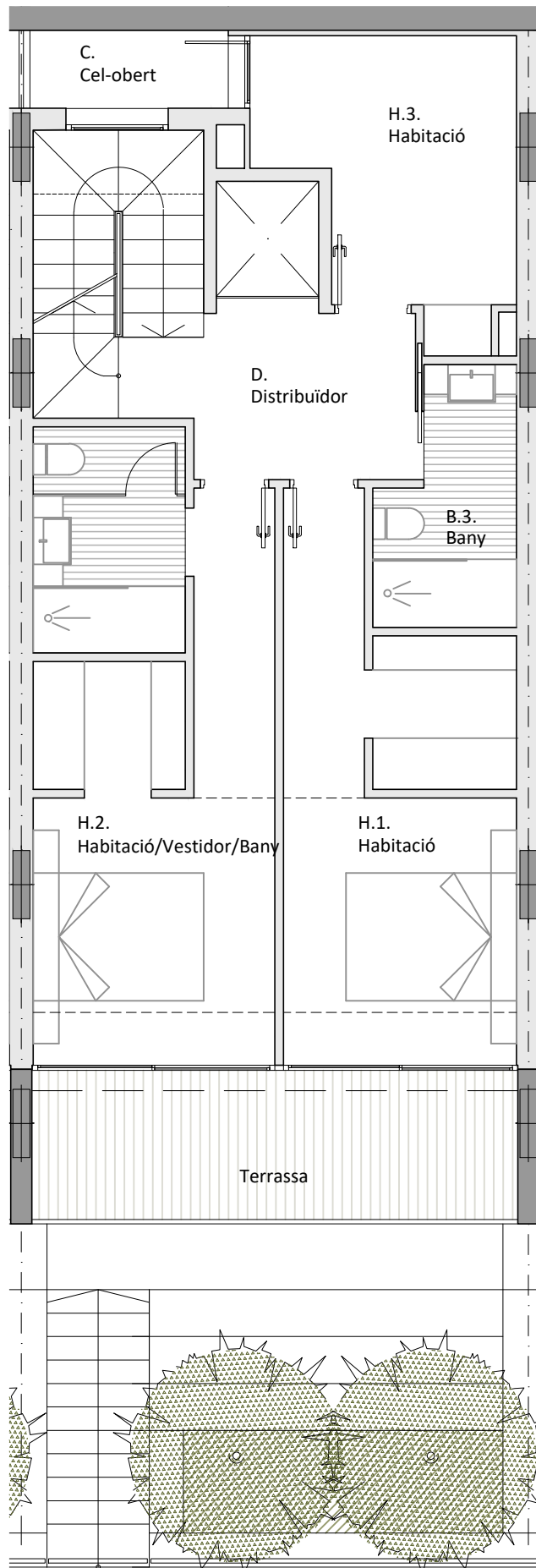

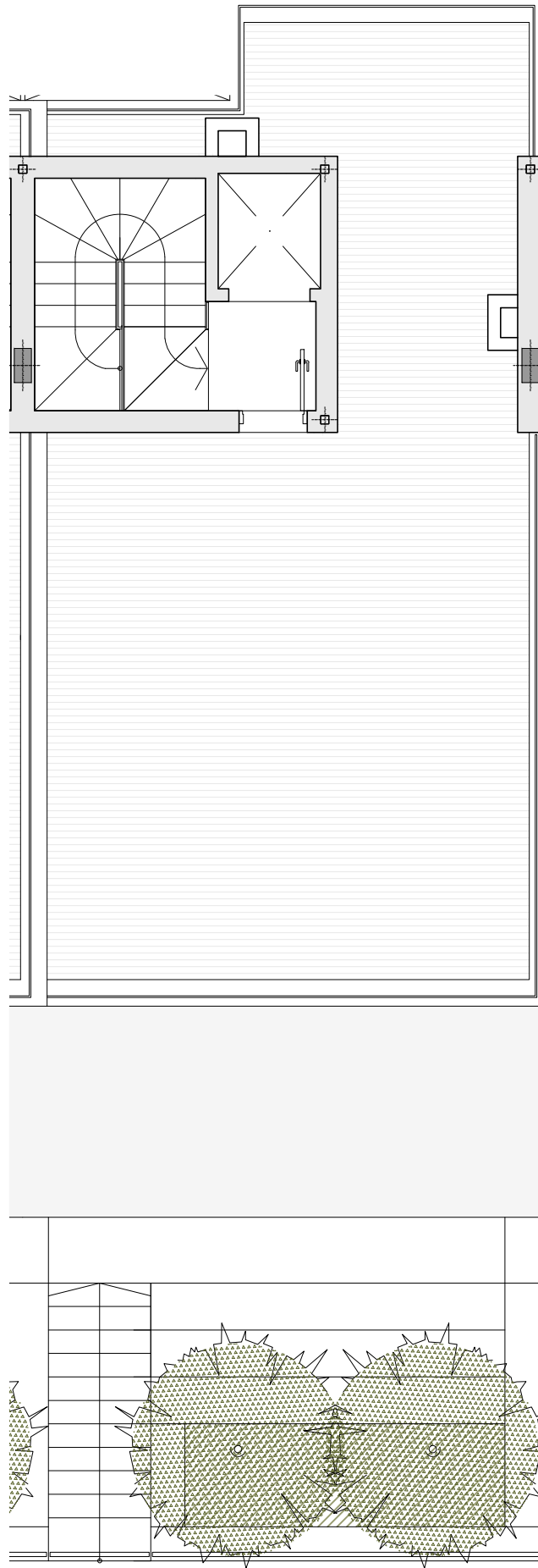

CASA 2

Planta coberta

Superfície construïda = 10,62 m²

Superfície transitable = 36,26 m²

 e: 1/75 (A4)